

VsP Series

Hybrid High-Performance Injection Moulding Machine



VsP Series

60-260 Tons VsP Series Simple,
Productive, Economical



Five-points double toggle clamping system &
Self-lubricating bushings

Integrated guide armrest design

Electrical mold height adjustment

Sliding shoe support moving platen (80T~250T)

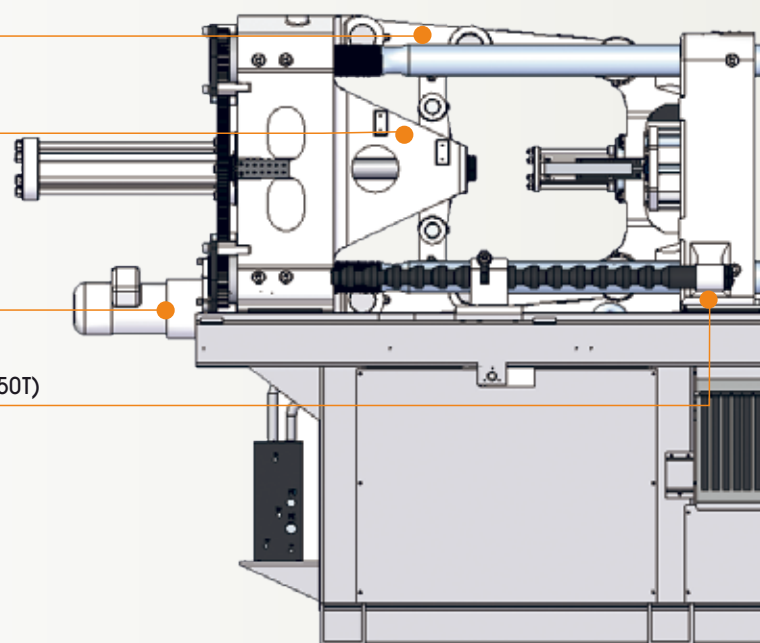



With a powerful V8800 controller and a high efficacy gear pump driven by P.M. Synchronous servomotor to satisfy your energy saving, requirement and achieves the outstanding process consistency and repeatability.

Victor Taichung VsP Series injection moulding machine has been developed by fusing of merits of hydraulic injection machines (low maintenance-free operation, long life, and low cost) and electric molding machines (energy-saving, high-velocity injection, quick response, high repeatability, and low operation noise)

The innovative new servo motor with high efficacy gear pump system, achieves energy-saving operation and quick response equivalent to those of all electric injection molding machines.



- Energy saving-almost equivalent to all- electric model machine.
- Quick response-Injection response time (Standard mode).
- Stability in low-velocity/low-pressure & wide range-Injection velocity: From ultra-low to high velocity range.
- Linearity-Excellent linearity in both injection velocity and injection pressure.
- Excellent injection holding pressure performance-Capability in sustaining high injection holding pressure longer (as compared with full-electric machine).
- Reduction in the amount of hydraulic oil and cooling water volume.
- Silent! (Low noise gear pump operation) Almost equivalent to all electric injection molding machine.

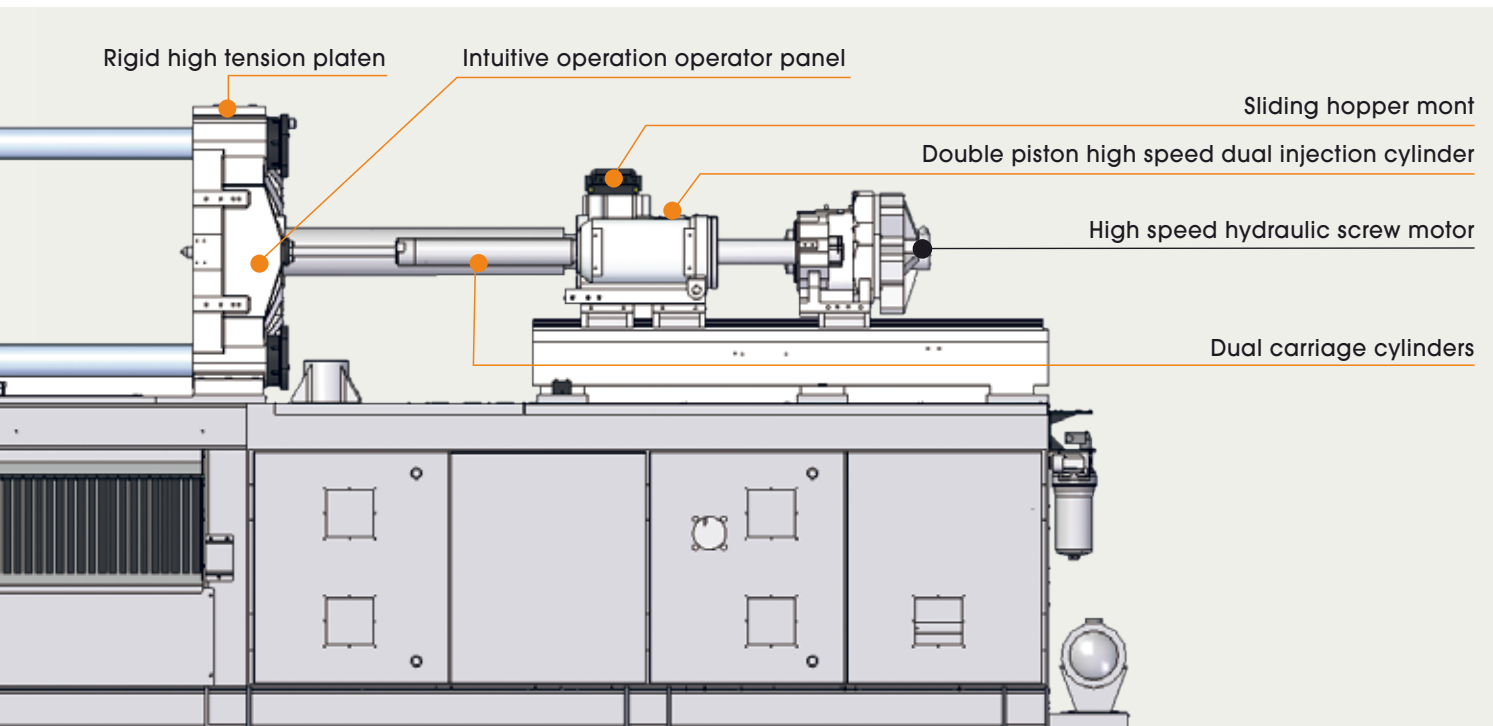

High Precision Injection Unit

The VsP Series optimum screw geometry plus the perfected drive and injection concepts provides excellent plasticising and injection capacity. Newly developed high wear and corrosion resistance ion-nitrided screw and barrel gives the customer a wide choice of materials for numerous applications. The gently prepared and properly homogenised melt is metered accurately, shot after shot, and is injected into the mould with high power and high speed.



The screw and barrel used on the Victor machines has the following properties.

- Injection screw ACM2 German material
- Surface hardness: 900~1100 HV
- Processed by Nitride (500~520°C for 72hrs)
- Nitrided thickness: 0.4~0.5 mm



Bi-metallic coating screw and barrel (Option) - SKD 61 base material. Excellent wear-resistant, corrosion resistant screw & barrel for the processing of materials with fiber additives and also fire retardant materials. Victor general purpose screw and barrels can process any kind of material like PE, PP, PA, ABS,AS. We also supply an optional screw & barrel for engineering materials like PC, PBT, PET, with an L/D ratio from 18, 20, 22.

The multi-notch locking style screw tip. the locking style tip is useful for stabilizing part weight and increasing product precision comparing the convectional screw tip. the gap between the screw and check ring is reduced to the least, thereby the back flow resin can be reduced to minimum.



Heavy Duty, Rigid, Clamping Unit

Every component in the clamping unit that is subjected to a mechanical stress was designed and checked using the F.E.M (Finite element method) method of structure analysis. All VsP Series machines feature a unique, ultra-reliable, five-point toggle clamping mechanism, which is characterised, by an almost ideal kinematic velocity feature. This system has fast speed, high force ratio, sensitive mould protection and good energy saving capabilities. The large square cast iron platens are extremely robust and the widely spaced tie bars allow for even the most complex of moulds.

The large, square cast iron platens virtually eliminate deflection. The bushings are manufactured from graphite impregnated phosphor bronze. Designed to run totally oil-free, there's no chance of contaminating molds, and maintenance is limited to long periodic greasing.



Material:

Platen: Meehanite casting FCD 55
 Tie bar: NH48MV (from Japan)
 Toggle pin: SCM440 (hard chrome plating)

Advantage:

- * Machine life = 15 years more
- * Eliminates the oil pollution
- * Saves maintenance time

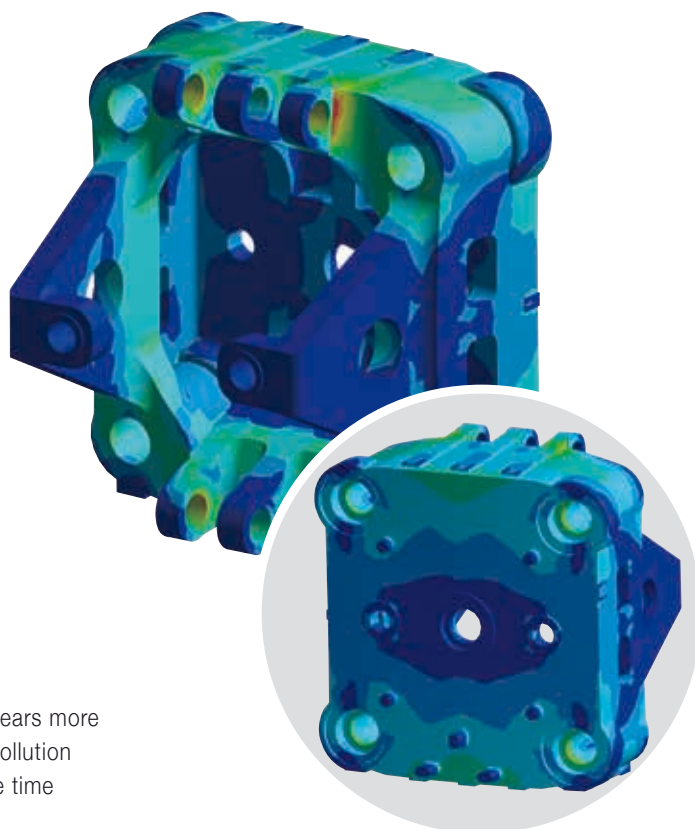
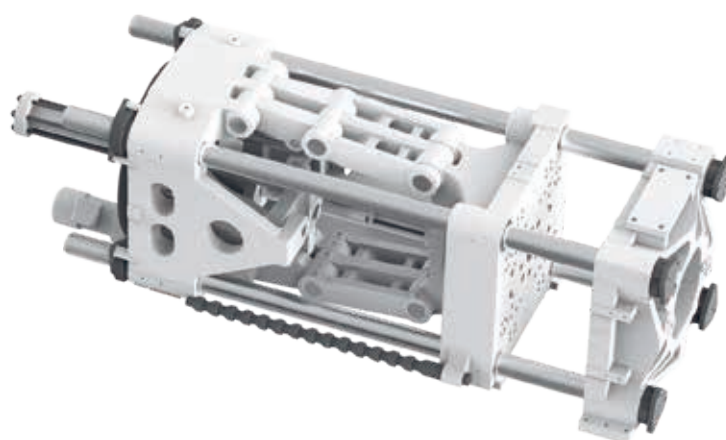

Mould height adjustment, which is the bull gear system, is operated by an electrical brake motor and when co-ordinated with a precision circuit breaker proceeds to prevent the possibility of overloading by force and cause machine damage.

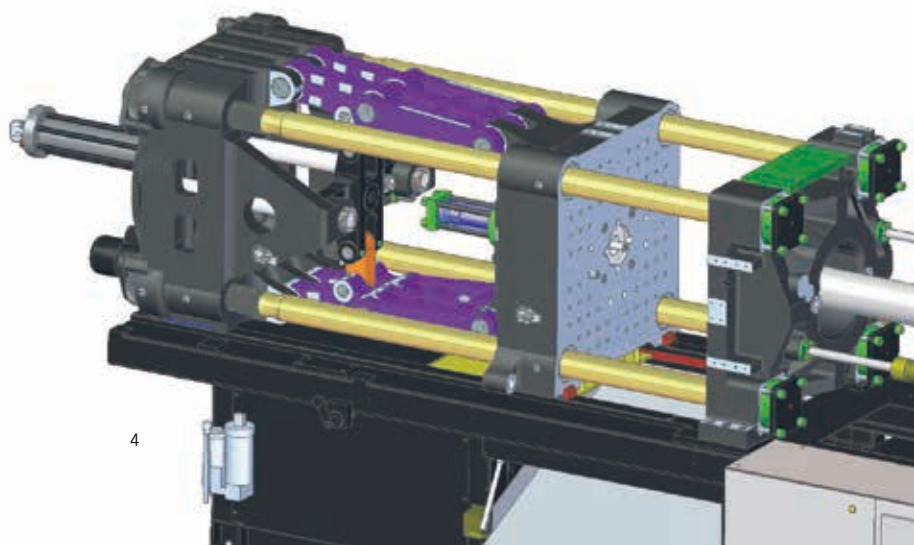

Energy Saving system (Option)

Servo driven pump with variable speed drives for injection moulding machine.

Cost reduction by energy efficiency in Plastic Machinery.

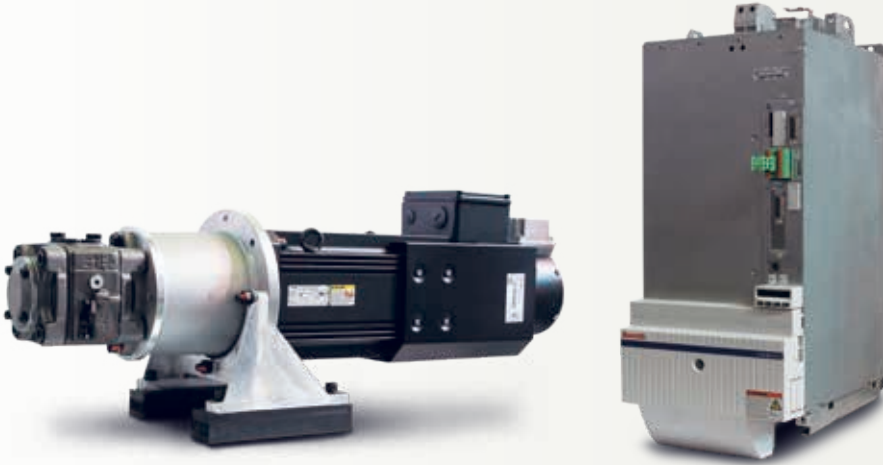

Request on drive system

- Reduced energy cost.
- Reduced installed power.
- Less secondary measures for reduction of noise.
- Reduced cost for oil cooling.

Comparison with traditional fixed pump with constant speed.

Example: Load sensing

72.3% energy saving

Model: VsP-50T

75s cycle times

const. speed (15kW): 2.9 kW

SVP: 0.8 kW

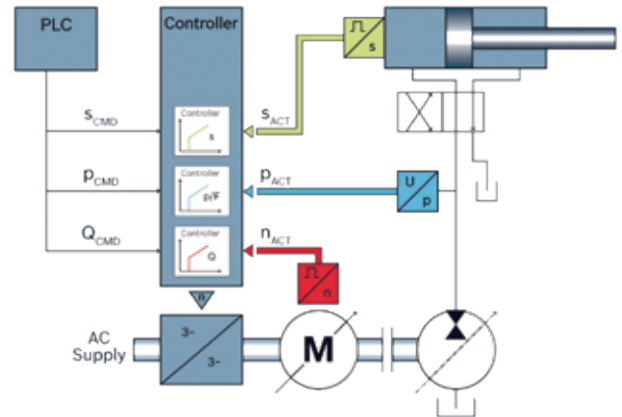

Power consumption

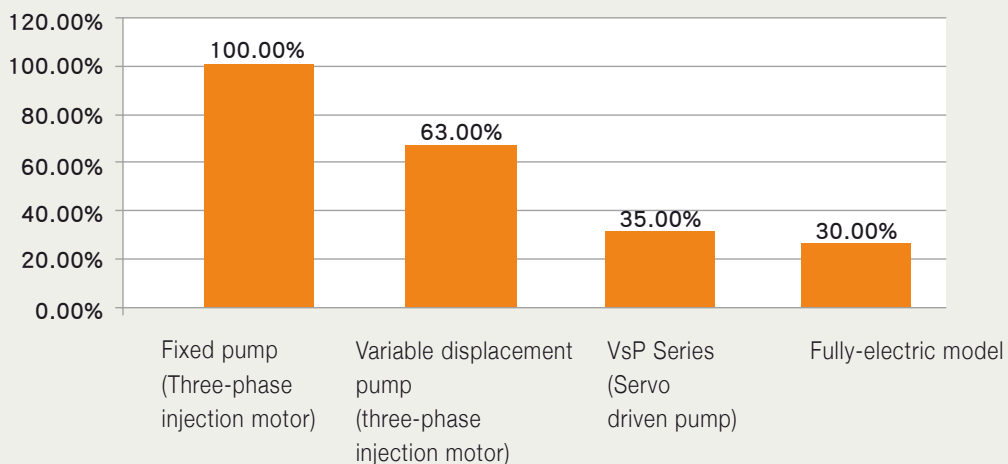

Hybrid Hydraulic Control (Option - servomotor pump)

VsP Series injection molding machine every moving steps require pressure and flow control by high-efficacy gearpump collocating with powerful permanent-magnet synchronous servo motor. This series machine is availability of energy saving up to 60~75% as compared with the traditional hydraulic machine.

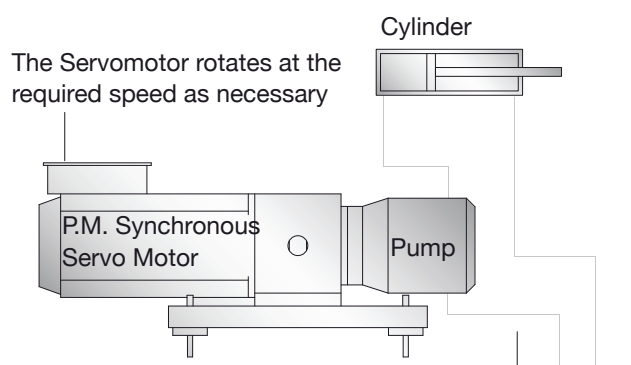

Pressure: Torque of Servomotor / Pressure transducer.
Flow: Revolution speed of Servomotor

- Piston seal: NOK (Japan)/Hallite
- Cylinder seal: NOK (Japan)
- O-Ring: NOK (Japan)
- Back-up Ring: NOK (Japan)

The VsP Series (120T~260T models) adopts logic valves in its hydraulic system circuits. The logic valves give high response performance in injection and mould travelling stages and offers 5% energy reduction due to low-pressure loss, and can guarantee a long service life. Less energy loss means lower heat build-up in addition to a substantial reduction in the requirement of cooling water. This is further help automatic regulation of the hydraulic oil temperature.

VsP Energy Saving SVP system (Injection close-loop feedback control):

The pressure transducer measures the real injection cylinder and feedback to P/Q control module for the close-loop pressure compensation. The servo motor rpm encoder measures and feedback the pump flow to P/Q control module for the speed compensation to get precision relativity control.

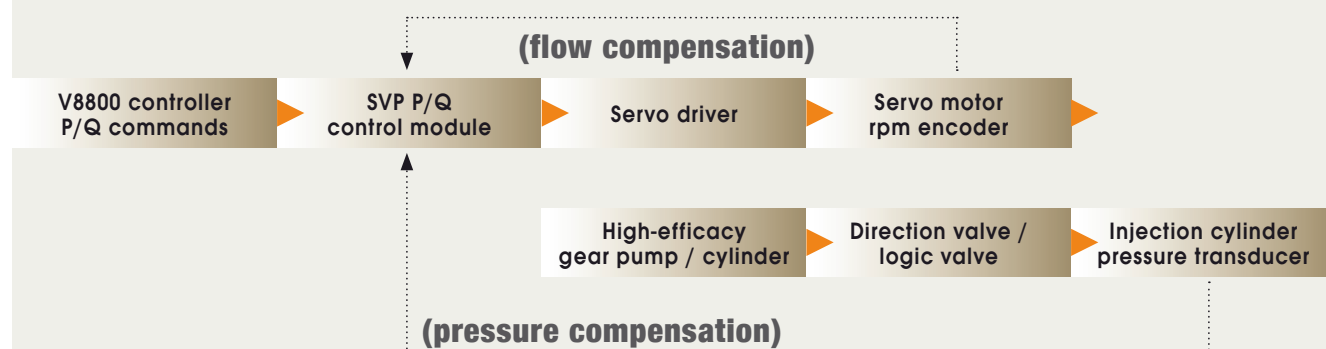

New Generation V8800 Control

Intuitive 15 inch touch screen framed with keyboard

The swivel mounted 15" LCD high resolution touch screen, graphical user interface, can be optimally positioned for each operator, allowing an easy setting position and easy access to the mould area.

Lighted on/off manual movement buttons for each axis.

Simple Friendly Operation interface

Mold settings can be transferred using a USB drive

The internal memory allows for up to 1000 set to be stored, the USB port enables molding condition files to be stored to an external USB memory stick.



Overall setting screen

- Single screen for setting clamp, ejector, injection, temperature, air-blast and charging etc.
- Great for quick setups and adjustments.
- Improves operator setup efficiency.



Pop-up keyboards for data and text entry

Touch screen panel/Pop-up keyboard for data and text entry. Drop down selection boxes for choosing items from a list.

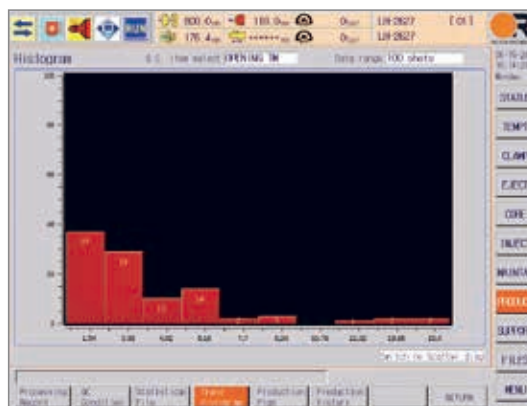

SPC/SQC Production management - quality control

Process cycle data maintains information over the last 10,000 cycles allowing for quick analysis of process history. This data can be printed, and save to USB sticker, for off line Excel analyzing.

The Setting Page Of Controller V8800 Series

Machine Status

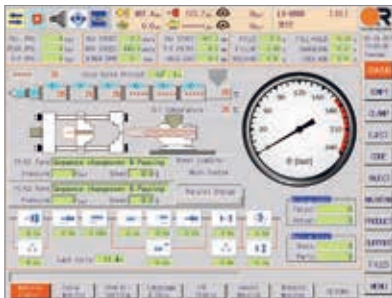

WeekTime & Auto Tuning



Inject & Holding



Charge & Suckback



Clamp Setting



Barrel Temperature



Corepull on Ejection



Mold Setup



Cycle Monitor



Injection Curve



Injection Unit

	Vsp-60	Vsp-90	Vsp-120	Vsp-150	Vsp-180	Vsp-220	Vsp-260
Pivoting injection unit	S	S	S	S	S	S	S
Cold start protection	S	S	S	S	S	S	S
Six injection speed & pressure steps	S	S	S	S	S	S	S
Four holding pressures stages	S	S	S	S	S	S	S
V-P switchover time, position and cylinder pressure dependent	S	S	S	S	S	S	S
V-P switchover cavity pressure dependent	O	O	O	O	O	O	O
Control for intrusion injection	S	S	S	S	S	S	S
PID temperatures control	S	S	S	S	S	S	S
Thermocouple controlled nozzle zone	S	S	S	S	S	S	S
Screw suck back with open nozzle	S	S	S	S	S	S	S
Spring shut-off nozzle	O	O	O	O	O	O	O
Hydraulic or pneumatic actuated needle shut-off nozzle.	O	O	O	O	O	O	O
Slide-away stainless steel hopper for quick material change	S	S	S	S	S	S	S
High wear resistant plasticising units	S	S	S	S	S	S	S
Thermoset processing unit	O	O	O	O	O	O	O
Rigid PVC processing unit	O	O	O	O	O	O	O
Adjustable nozzle force	O	O	O	O	O	O	O
Delayed nozzle retraction	S	S	S	S	S	S	S
Stainless steel barrel cover	S	S	S	S	S	S	S
Nozzle guarding	S	S	S	S	S	S	S
Automatic heating and pre-heating	S	S	S	S	S	S	S
Additional temperature zones	O	O	O	O	O	O	O
RPM display	S	S	S	S	S	S	S
Control for automatic purging	S	S	S	S	S	S	S
Low torque / Extra high speed hydraulic screw motor	O	O	O	O	O	O	O
Screw speed adjustable via screen	S	S	S	S	S	S	S
Bimetallic screw and barrel	O	O	O	O	O	O	O
Ceramic heater bands	O	O	O	O	O	O	O
Feed throat zone temperature display	S	S	S	S	S	S	S
Feed throat zone temperature control	O	O	O	O	O	O	O
Hopper (+ magnet)	O	O	O	O	O	O	O
Auto loader	O	O	O	O	O	O	O
Vented screw and barrel	O	O	O	O	O	O	O
Barrel temperature display with set value and deviation	S	S	S	S	S	S	S
Plasticising time monitor	S	S	S	S	S	S	S
Injection unit forward / back speeds adjustable	S	S	S	S	S	S	S
Suck-back before or after metering	S	S	S	S	S	S	S
Thermocouple breakage alarm	S	S	S	S	S	S	S
Injection endpoint control	S	S	S	S	S	S	S
Barrel cooling fan	O	O	O	O	O	O	O
Twin carriage cylinder	S	S	S	S	S	S	S
Insulated blanket for plasticizing barrel	O	O	O	O	O	O	O
Long nozzle	S	S	S	S	S	S	S
Injection controlled by linear transducer	S	S	S	S	S	S	S
Carriage controlled by linear transducer	O	O	O	O	O	O	O
Oil heated barrel (some thermoset materials)	O	O	O	O	O	O	O
Heater bands up to 450° C	O	O	O	O	O	O	O
Braided heater bands	O	O	O	O	O	O	O

S=Standard O=Option

Clamping Unit

	VsP-60	VsP-90	VsP-120	VsP-150	VsP-180	VsP-220	VsP-260
Five mould closing / open speed ranges with four adjustable speeds	S	S	S	S	S	S	S
Mould height adjustment by electric break motor	S	S	S	S	S	S	S
Hydraulic ejector with adjustable speed, pressure and position and no. strokes	S	S	S	S	S	S	S
Hydraulic unscrew device	O	O	O	O	O	O	O
Core pull x 1, Air blow x 1	S	S	S	S	S	S	S
Core pull x 2, Air blow x 2	O	O	O	O	O	O	O
Core pull x 3, Air blow x 3	O	O	O	O	O	O	O
Mechanical scotch bar	S	S	S	S	S	S	S
Pneumatic operated safety gate	O	O	O	O	O	O	O
Stainless steel drop chute	S	S	S	S	S	S	S
Mould lifting crane	O	O	O	O	O	O	O
Phosphor bronze, graphite impregated toggle bushings	S	S	S	S	S	S	S
Chromium plated tie bars	S	S	S	S	S	S	S
Clamping measurement by linear transducer	S	S	S	S	S	S	S
Mould safety devices (Low pressure protection)	S	S	S	S	S	S	S
Platen holes and locating ring to Euromap or SPI or JIS specifications	S	S	S	S	S	S	S
Additional mould height	O	O	O	O	O	O	O
Mould safety gate operator and rear side	S	S	S	S	S	S	S
Robot fixing holes on top of fixed platen	S	S	S	S	S	S	S
Manual lubrication system	S	S	S	S	S	S	S
Auto clamping force set-up	S	S	S	S	S	S	S
Ejector stroke controller by linear transducer	S	S	S	S	S	S	S
Ejector retract confirmed interface (Euromap-13)	O	O	O	O	O	O	O
FCD 55 casted platens	S	S	S	S	S	S	S
Ejector forward when safety door open (Semi-auto mode / motion switch)	S	S	S	S	S	S	S
Next cycle start by closing safety door	O	O	O	O	O	O	O
Mould insulation plate	O	O	O	O	O	O	O

Hydraulic System

	VsP-60	VsP-90	VsP-120	VsP-150	VsP-180	VsP-220	VsP-260
Servo motor pump system	O	O	O	O	O	O	O
Pressure electronic display for system monitoring	S	S	S	S	S	S	S
Oil level monitoring	O	O	O	O	O	O	O
Return line oil filter	S	S	S	S	S	S	S
Oil suction filter	S	S	S	S	S	S	S
Maintenance hatch for cleaning and checking oil tank	S	S	S	S	S	S	S
High performance oil seals	S	S	S	S	S	S	S
Water / Air chiller	O	O	O	O	O	O	O
High precision directional / flow valves	S	S	S	S	S	S	S
Steel braded hydraulic pipe	S	S	S	S	S	S	S
Oil level detect and monitoring	O	O	O	O	O	O	O

S=Standard O=Option

Control & Electrical Unit

	VsP-60	VsP-90	VsP-120	VsP-150	VsP-180	VsP-220	VsP-260
Modular assembly, compact microprocessor with 240 mould data storage	S	S	S	S	S	S	S
Data interface for printer via USB memory stick	S	S	S	S	S	S	S
Data interface for computer connection USB	S	S	S	S	S	S	S
Reference hints and problem indicators in clear text	S	S	S	S	S	S	S
Hour, minute, second counter	S	S	S	S	S	S	S
Cycle counter	S	S	S	S	S	S	S
Part piece counter	S	S	S	S	S	S	S
Preselectable cycle counter with auto shut-off	S	S	S	S	S	S	S
Air eject programmable start and blow time	S	S	S	S	S	S	S
Tolerance monitoring of parameters	S	S	S	S	S	S	S
Standard SPC / SQC program	S	S	S	S	S	S	S
7-day timer for auto heating and preheating	S	S	S	S	S	S	S
Additional temperature control zones	O	O	O	O	O	O	O
Interface for temperature control devices	O	O	O	O	O	O	O
Alarm log	S	S	S	S	S	S	S
Multi language choice	S	S	S	S	S	S	S
Cycle, Filling & metering time indicator	S	S	S	S	S	S	S
Parts counter	S	S	S	S	S	S	S
Reject counter	S	S	S	S	S	S	S
Cushion control	S	S	S	S	S	S	S
Servo system transformer (220V/240V)	O	O	O	O	O	O	O

General Features

	VsP-60	VsP-90	VsP-120	VsP-150	VsP-180	VsP-220	VsP-260
3 Phase auto loader socket x1 220 / 380 / 460 Volts	S	S	S	S	S	S	S
Cabinet ventilation by fan	S	S	S	S	S	S	S
Heating and motor power are on separate circuits, switchable on or off	S	S	S	S	S	S	S
Solid state heat contacts for plasticising units	S	S	S	S	S	S	S
Part chute with sensor indicator cycle restart	O	O	O	O	O	O	O
Parts removal from both sides	O	O	O	O	O	O	O
Anti-vibration floor pads	S	S	S	S	S	S	S
Pneumatic cores pull	O	O	O	O	O	O	O
Mold water manifold (4~7 zones)	S	S	S	S	S	S	S
Mould heating zones	O	O	O	O	O	O	O
Hot runner regulators	O	O	O	O	O	O	O
Euromap 12/67 for robot interface	O	O	O	O	O	O	O
Conveyor belt	O	O	O	O	O	O	O
Masterbatch colour dosing interface	O	O	O	O	O	O	O
Tool kit	S	S	S	S	S	S	S
Euromap 13 Core-pulling interface	O	O	O	O	O	O	O
Euromap for mold heating interface	O	O	O	O	O	O	O
Electric power consumption display meter	O	O	O	O	O	O	O

S=Standard O=Option

JIS Platen Information

Moving platen

Fixed platen

VsP-60

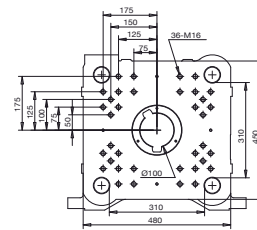
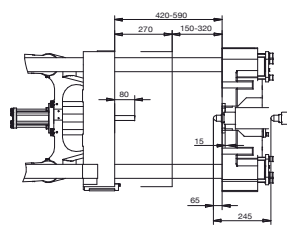
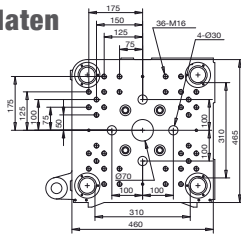

VsP-90

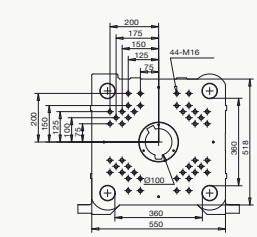
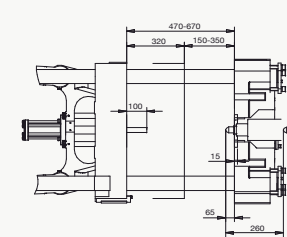
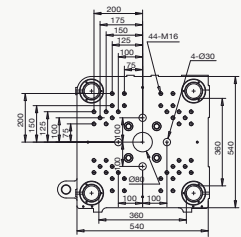

VsP-120

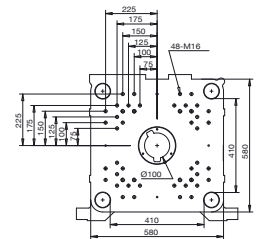
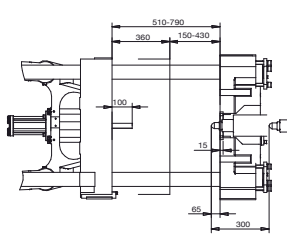
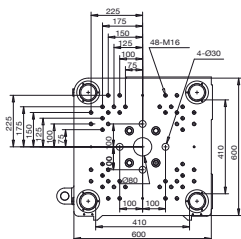

VsP-150

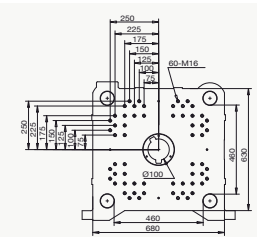
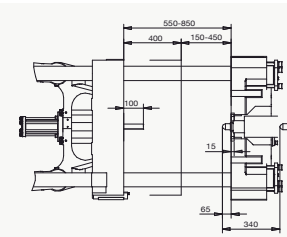
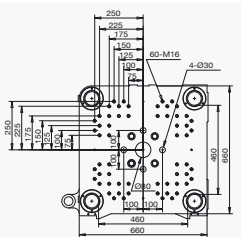

VsP-180

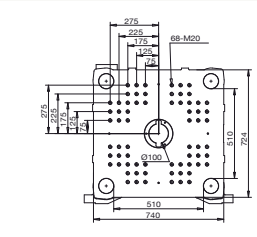
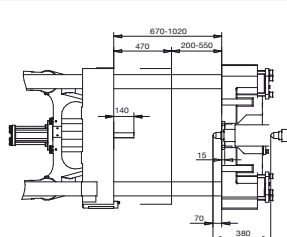
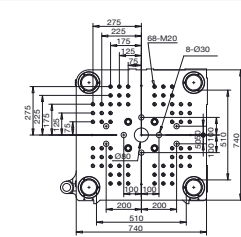

VsP-220

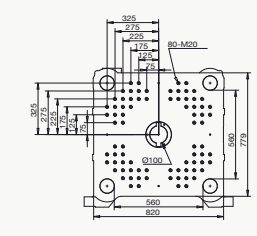
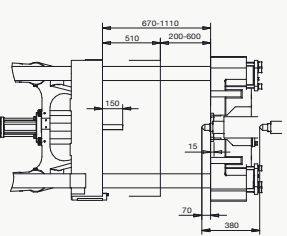
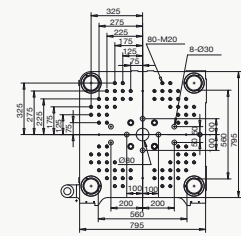

VsP-260

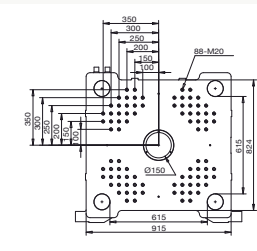
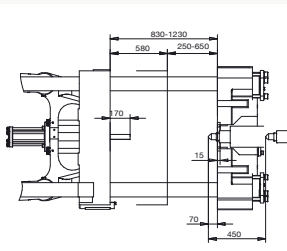
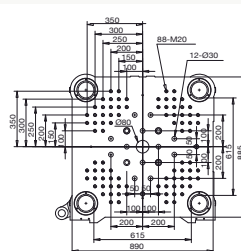

Euromap Platen Information

Moving platen

Fixed platen

VsP-60

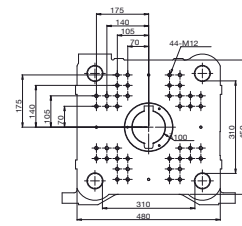
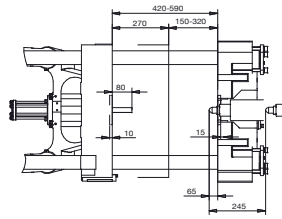
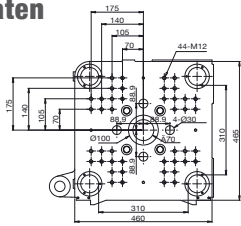

VsP-90

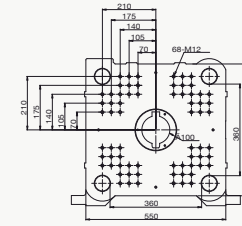
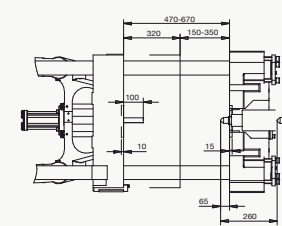
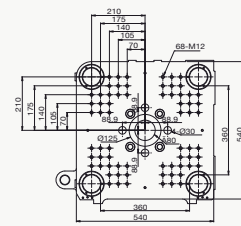

VsP-120

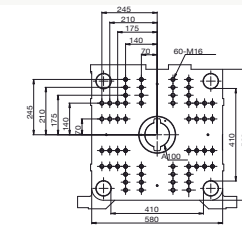
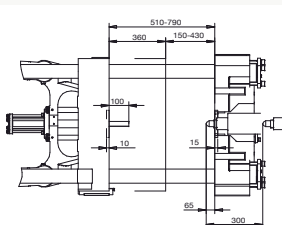
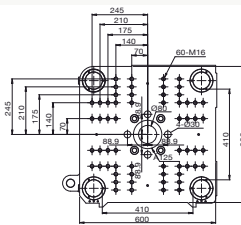

VsP-150

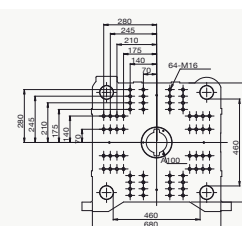
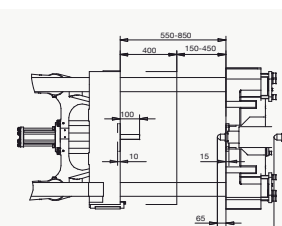
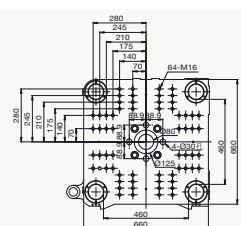

VsP-180

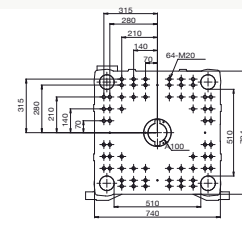
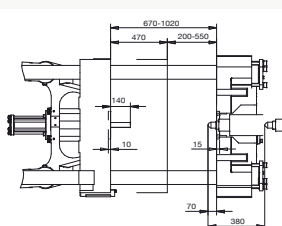
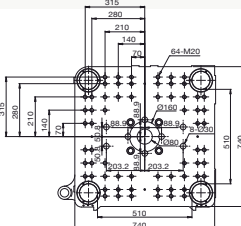

VsP-220

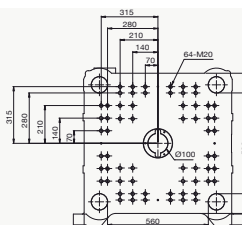
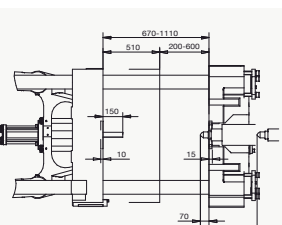
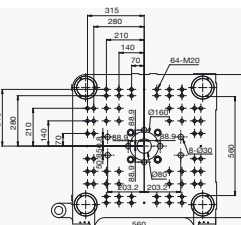

VsP-260

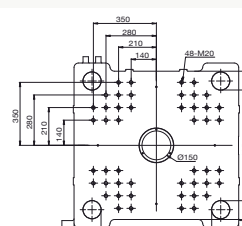
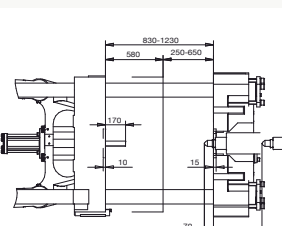
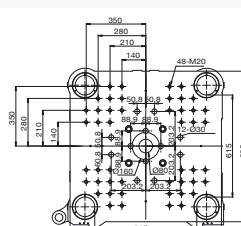

SPI Platen Information

Moving platen

Fixed platen

VsP-60

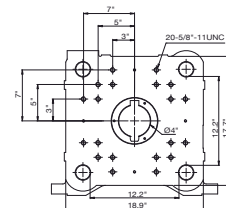
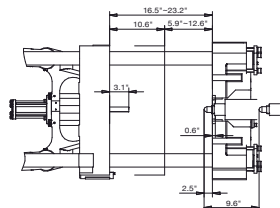
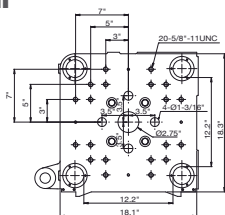

VsP-90

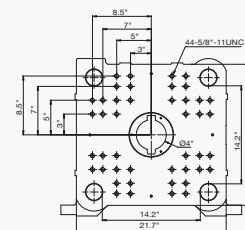
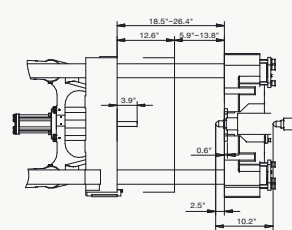
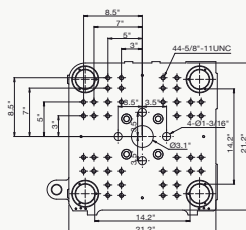

VsP-120

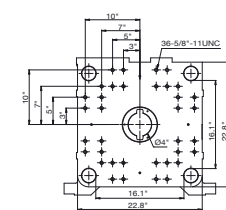
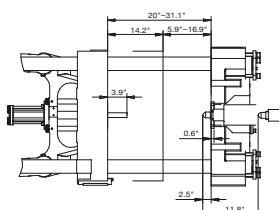
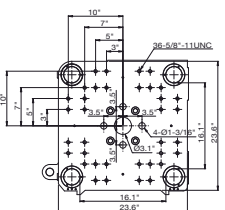

VsP-150

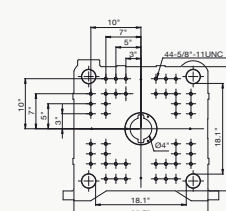
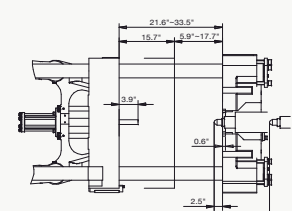
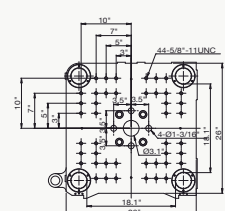

VsP-180

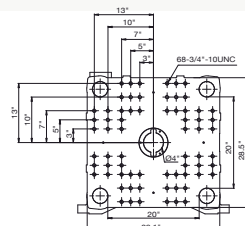
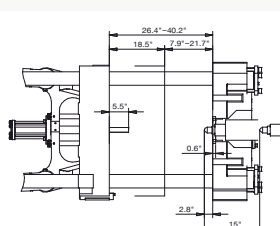
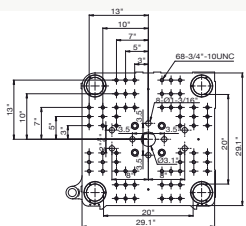

VsP-220

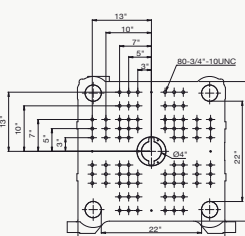
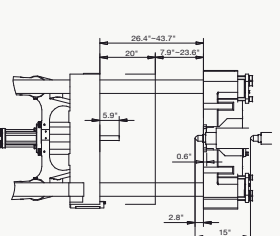
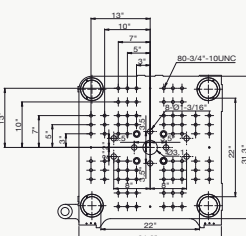

VsP-260

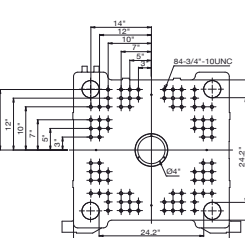
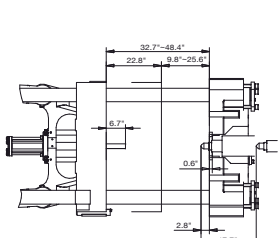
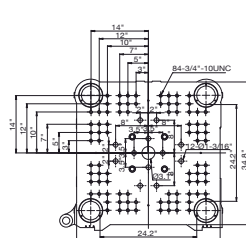

Euromap Specifications

		VsP-60					VsP-90					VsP-120									
Injection Unit																					
Injection unit size		S		K			S		K			M		K			M				
Screw Diameter	mm	22	25	28	32	36	22	25	28	32	36	32	36	40	28	32	36	32	36		
Calculated Injection Capacity	cm ³	38	49	62	80	102	38	49	62	80	102	117	148	182	62	80	102	117	148		
Actual Shot weight-PS	g	36	46	58	75	95	36	46	58	75	95	109	138	171	58	75	95	109	138		
	oz	1.3	1.6	2	2.6	3.3	1.3	1.6	2	2.6	3.3	3.8	4.9	6	2	2.6	3.3	3.8	4.9		
Actual Plasticizing Capacity-PS	g/s	5.55	7.77	9.72	14.44	20	5.55	7.77	9.72	14.44	20	10	13.88	18.61	10.55	15.27	21.11	10	13.88		
Injection Pressure-Max.	kgf/cm ²	2500	2332	2500	2017	1594	2500	2332	2500	2017	1594	2490	1968	1594	2500	2017	1594	2490	1968		
Injection rate	cm ³ /sec	53	69	86	113	142	66	85	107	140	177	113	144	177	107	140	177	113	144		
Calculated Injection Speed-Max.	mm/sec	140		140			175		175			141		175			141				
L/D ratio		22.4	20	22.9	20	17.8	22.7	20	22.9	20	17.8	22.5	20	18	22.9	20	17.8	22.5	20		
Screw Speed	rpm	400		378			400		378			266		400			266				
Screw stroke	mm	100		100			100		100			145		100			145				
Calculated Nozzle contact force	ton	5		5			5		5			5		5			5				
Total Heating wattage	kw	5.25		5.8			5.25		5.8			6.8		5.8			6.8				
Clamping unit																					
Clamping Force	ton	60					90					120									
Tie-Bar distance (H x V)	mm	310 x 310					360 x 360					410 x 410									
Mold thickness Min. - Max.	mm	150 - 320					150 - 350					150 - 430									
Clamp stroke-Max.	mm	270					320					360									
Open daylight-Max.	mm	590					670					790									
Platen dimensions (H x V)	mm	490 x 460					560 x 540					600 x 580									
Ejector stroke	mm	80					100					100									
Ejector force	ton	4					4					4									
Dry. Cycle time	sec.	2.6					2.5					3.2									
General																					
Servo Motor Pump (ES Option)	kw	11					20					20									
Oil tank capacity	l	135					185					190									
Hydraulic sys. Pressure	bar	170					170					170									
Machine weight	ton	2.3					2.9					3.4									
Machine size (L x W x H)	mm	3876 x 1095 x 1918					4122 x 1265 x 1928					4348 x 1231 x 2000									

※ Due to continual improvements, specifications technical information and dimensions are subject to change without prior notice.

VsP-150						VsP-180						VsP-220						VsP-260						
M			G			G			F			G			F			F			E			
40	32	36	40	36	40	46	36	40	46	46	50	55	36	40	46	46	50	55	46	50	55	55	60	68
182	117	148	182	163	201	266	163	201	266	332	393	475	163	201	266	332	393	475	332	393	475	570	679	872
171	109	138	171	153	188	249	153	188	249	312	368	445	153	188	249	312	368	445	312	368	445	534	636	817
6	3.8	4.9	6	5.4	6.6	8.8	5.4	6.6	8.8	11	13	15.7	5.4	6.6	8.8	11	13	15.7	11	13	15.7	18.8	22.4	28.8
18.61	13.05	18.05	24.16	15.83	20.83	30.55	21.38	27.77	40.83	26.11	32.5	40.55	21.66	27.77	40.83	26.11	32.5	40.55	32.22	39.72	49.72	30	37.22	50
1594	2490	1968	1594	2428	1967	1487	2428	1967	1487	2250	1904	1574	2428	1967	1487	2250	1904	1574	2250	1904	1574	2065	1735	1351
177	147	187	231	151	187	247	186	230	304	201	238	288	186	230	304	201	238	288	251	297	360	274	326	419
184			149			183			121			183			121			152			115			
18	22.5	20	18	22.2	20	17.4	22.2	20	17.4	21.7	20	18.2	22.2	20	17.4	21.7	20	18.2	21.7	20	18.2	21.8	20	17.6
345			296			397			255			397			255			312			188			
145			160			160			200			160			200			200			240			
5			5			5			5			5			5			5			7.9			
6.8			8.1			8.1			12.9			8.1			12.9			12.9			18.6			
150						180						220						260						
460 x 460						510 x 510						560 x 560						615 x 615						
150 - 450						200 - 550						200 - 600						250 - 650						
400						470						510						580						
850						1020						1110						1230						
690 x 660						750 x 724						795 x 779						890 x 860						
100						140						150						170						
4						5.6						5.6						8.5						
3.1						3.3						3.5						3.5						
20						22						22						31						
190						280						280						350						
170						170						170						170						
4						5.4						6.2						9.3						
4466 x 1280 x 2072						5268 x 1487 x 2289						5548 x 1497 x 2349						6330 x 1582 x 2388						

SPI Specifications

		VsP-60						VsP-90						VsP-120					
Injection Unit																			
Injection unit size		S		K			S		K			M			K				
Screw Diameter	in	0.86	0.98	1.1	1.25	1.41	0.86	0.98	1.1	1.25	1.41	1.25	1.41	1.57	1.1	1.25	1.41	1.25	
Calculated Injection Capacity	in ³	2.31	2.99	3.78	4.88	6.22	2.31	2.99	3.78	4.88	6.22	7.14	9.03	11.1	3.78	4.88	6.22	7.14	
Actual Shot weight-PS	g	36	46	58	75	95	36	46	58	75	95	109	138	171	58	75	95	109	
	oz	1.3	1.6	2	2.6	3.3	1.2	1.6	2	2.6	3.3	3.8	4.9	6	2	2.6	3.3	3.8	
Actual Plasticizing Capacity-PS	g/s	5.55	7.77	9.72	14.44	20	5.55	7.77	9.72	14.44	20	10	13.88	18.61	10.55	15.27	21.11	10	
Injection Pressure-Max.	Psi	35557	33168	35557	28687	22671	35557	33168	35557	28687	22671	35415	27976	22657	35557	28687	22671	35415	
Injection rate	in ³ /sec	3.23	4.21	5.24	6.89	8.66	4.02	5.18	6.52	8.54	10.8	6.89	8.78	10.8	6.52	8.54	10.8	6.89	
Calculated Injection Speed-Max.	in/sec	5.51		5.51			6.88		6.88			5.55			6.88				
L/D ratio		22.4	20	22.9	20	17.8	22.7	20	22.9	20	17.8	22.5	20	18	22.9	20	17.8	22.5	
Screw Speed	rpm	400		380			400		400			250			400				
Screw stroke	in	3.937		3.937			3.937		3.937			5.7			3.937				
Calculated Nozzle contact force	U.S. ton	5.5		5.5			5.5		5.5			5.5			5.5				
Total Heating wattage	kw	5.25		5.8			5.25		5.8			6.8			5.8				
Clamping unit																			
Clamping Force	U.S. ton	66.1						99.2						132.2					
Tie-Bar distance (H x V)	in	12.2 x 12.2						14.1 x 14.1						16.1 x 16.1					
Mold thickness Min. - Max.	in	5.9 - 12.59						5.9 - 13.77						5.9 - 16.92					
Clamp stroke-Max.	in	10.629						12.598						14.173					
Open daylight-Max.	in	23.228						26.377						31.102					
Platen dimensions (H x V)	in	19.2 x 18.1						22 x 21.2						23.6 x 22.8					
Ejector stroke	in	3.149						3.937						3.937					
Ejector force	U.S. ton	4.409						4.409						4.409					
Dry. Cycle time	sec.	2.6						2.5						3.2					
General																			
Servo Motor Pump (ES Option)	kw	11						20						20					
Oil tank capacity	L	150						165						165					
Hydraulic sys. Pressure	Psi	2417						2417						2417					
Machine weight	U.S. ton	2.535						3.086						3.747					
Machine size (L x W x H)	in	152.59 x 43.11 x 75.51						162.28 x 49.8 x 75.91						171.18 x 48.46 x					

VsP-150					VsP-180					VsP-220					VsP-260										
M	M		G		G		F		G		F		F		E										
1.41	1.57	1.25	1.41	1.57	1.41	1.57	1.81	1.41	1.57	1.81	1.81	1.96	2.16	1.41	1.57	1.81	1.81	1.96	2.16	1.81	1.96	2.16	2.16	2.36	2.67
9.03	11.1	7.14	9.03	11.1	9.94	12.2	16.2	9.94	12.2	16.2	20.2	23.9	28.9	9.94	12.2	16.2	20.2	23.9	28.9	20.2	23.9	28.9	34.7	41.4	53.2
138	171	109	138	171	153	188	249	153	188	249	312	368	445	153	188	249	312	368	445	312	368	445	534	636	817
4.8	6	3.8	4.9	6	5.4	6.6	8.8	5.4	6.6	8.8	11	13	15.7	5.4	6.6	8.8	11	13	15.7	11	13	15.7	18.8	22.4	28.8
13.88	18.61	13.05	18.05	24.16	15.83	20.83	30.55	21.38	27.77	40.83	26.11	32.5	40.55	21.66	27.77	40.83	26.11	32.5	40.55	32.22	39.72	49.72	30	37.22	50
27976	22657	35415	27976	22657	30949	27976	21149	30991	27976	21149	32001	27080	22387	30991	27976	21149	32001	27080	22387	32001	27080	22387	29370	24676	19215
8.78	10.8	8.97	11.41	14.09	9.21	11.41	15.07	11.35	14.03	18.55	12.26	14.52	17.57	11.35	14.03	18.55	12.26	14.52	17.57	15.31	18.12	21.96	16.72	19.89	25.57
5.55	7.24		5.86		7.2		4.76		7.2		4.76		5.98		4.52										
20	18	22.5	20	18	22.2	20	17.4	22.2	20	17.4	21.7	20	18.2	22.2	20	17.4	21.7	20	18.2	21.7	20	18.2	21.8	20	17.6
250	315		277		355		255		355		255		312		186										
5.708	5.708		6.299		6.299		7.874		6.299		7.874		7.874		9.448										
5.5	5.5		5.5		5.5		5.5		5.5		5.5		5.5		8.7										
6.8	6.8		8.1		8.1		12.9		8.1		12.9		12.9		18.6										

	165.3					198.4					242.5					286.5				
	18.1 x 18.1					20 x 20					22 x 22					24.2 x 24.2				
	5.9 - 17.71					7.87 - 21.65					7.87 - 23.62					9.84 - 25.59				
	15.748					18.503					20.078					22.834				
	33.464					40.157					43.7					48.425				
	27.1 x 25.98					29.52 x 28.5					31.29 x 30.66					35.03 x 33.85				
	3.937					5.511					5.905					6.692				
	4.409					6.172					6.172					9.369				
	3.1					3.3					3.5					3.5				

	20					22					22					31				
	215					245					245					450				
	2417					2417					2417					2417				
	4.409					5.952					6.834					10.251				
78.74	175.82 x 50.39 x 81.57					207.4 x 58.54 x 90.11					218.42 x 58.93 x 92.48					249.21 x 62.28 x 94.01				

Example of standard/ optional equipment

Accessory	Stand	Option
Tool/ fuse kit	●	
Part drop chute	●	
Conveyor belt		●
Standard 5-in's/ 5-out's water regulator without flow indicator	●	
4 or extra zones water regulator with the flow indicator		●
220V/ 380VAC outlet x 1 for auto loader	●	
110VAC outlet receptacle (power sourced by customer)		●
110VAC outlet receptacle (power sourced via machine)		●
AC 220V/ 380VAC outlet receptacle (power sourced by customer)		●
AC 220V/ 380VAC outlet receptacle (power sourced via machine)		●
Transformer for local power source		●

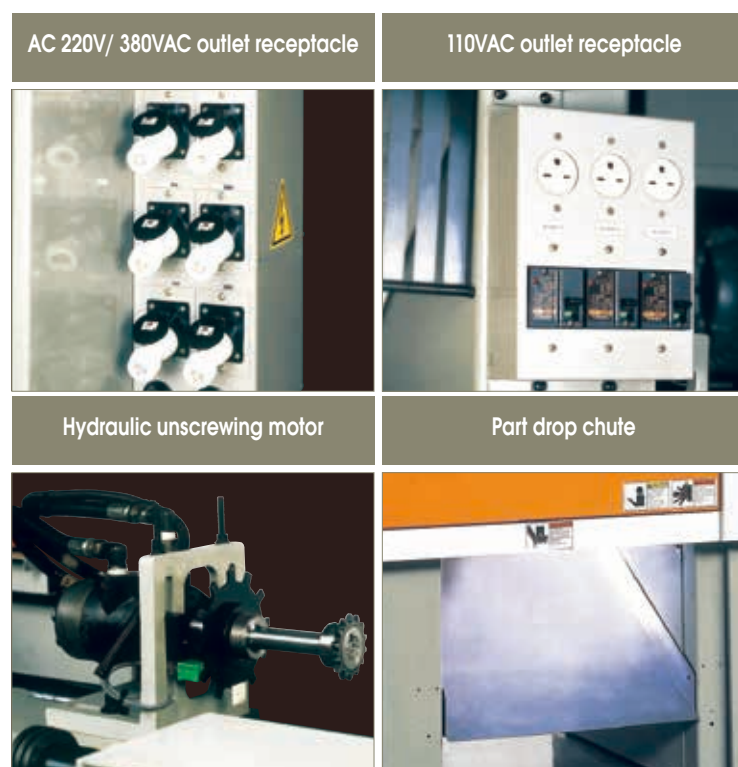

A Grade bimetallic barrel and screw set- with 40% tungsten carbide composition included in the barrel's bimetallic content, coupled with a screw which entire surface is fully hardened through HP/HVOF coating treatment process.

B Grade bimetallic barrel and screw set- with 25% tungsten carbide composition included in the barrel's bimetallic content, coupled with a screw which entire surface is fully hardened through HP/HVOF coating treatment process.

Sectional drawing of screw spindle with HP/HVOF treatment (A & B Grade Screw Spindle)

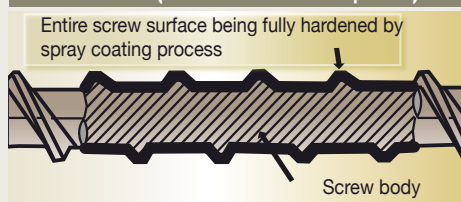

C Grade bimetallic barrel and screw set- with 9.5% tungsten carbide composition included in the barrel's bimetallic content, coupled with a screw which only the flights-tip is hardened through PTA Bimetallic alloy treatment process.

Sectional drawing of screw spindle with PTA treatment (C Grade Screw Spindle)

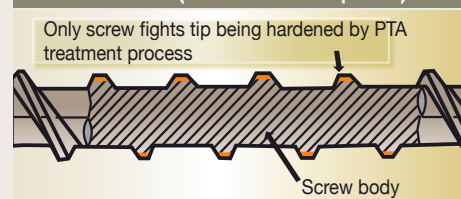

Notes:

- There are A, B and C three grades of bimetallic screw & barrel available, which can be selected by customer depending on what abrasive/corrosive engineering resin & additives used for molding application.
- For further information details, please contact Victor's sales.



Robot Installation Measurement Stationary Platen top View part

Robot mounting holes & Robot seat available mounting space

VsP-60

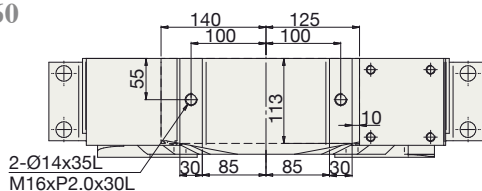

VsP-90

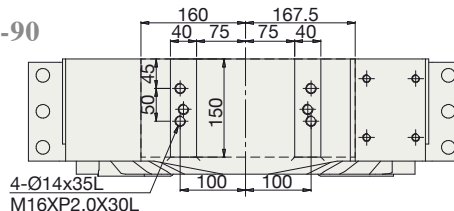

VsP-120

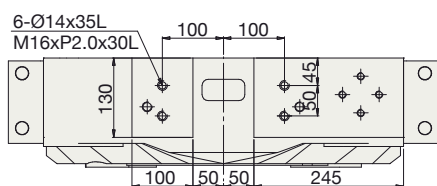

VsP-150

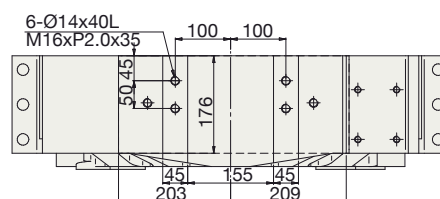

VsP-220

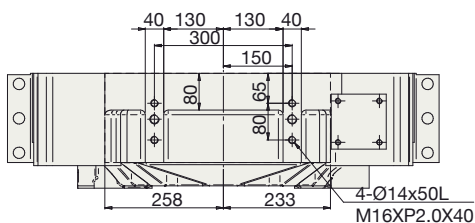

VsP-180

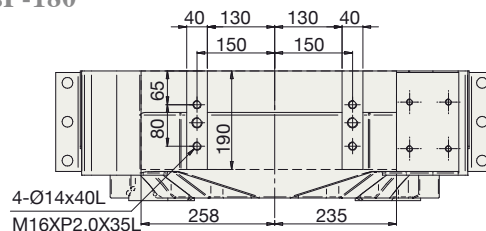

VsP-260

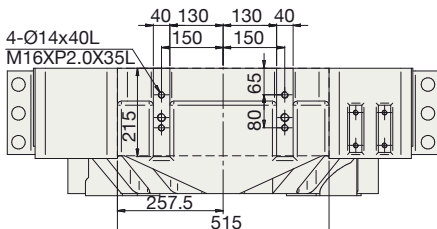

Various measurement relations

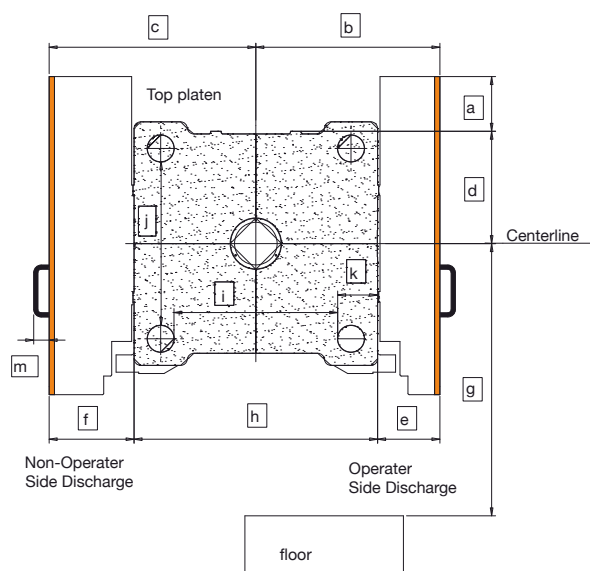

	a	b	c	d	e	f
VsP-60	70	455	525	258	210	280
VsP-90	70	480	546	292	200	266
VsP-120	64	530	585	338	235	290
VsP-150	75	555	610	348	210	265
VsP-180	75	595	645	400	220	270
VsP-220	69.5	658	672	418	242	256
VsP-260	178	692	777	450	230	315
	g	h	i	j	k	m
VsP-60	1255	490	310	310	40	58
VsP-90	1255	560	360	360	40	58
VsP-120	1310	590	410	410	25	58
VsP-150	1345	690	460	460	45	58
VsP-180	1380	750	510	510	35	58
VsP-220	1440	832	560	560	46	58
VsP-260	1380	923	615	615	54	58

Unit : mm

Machine Layout (excl. Transformer)

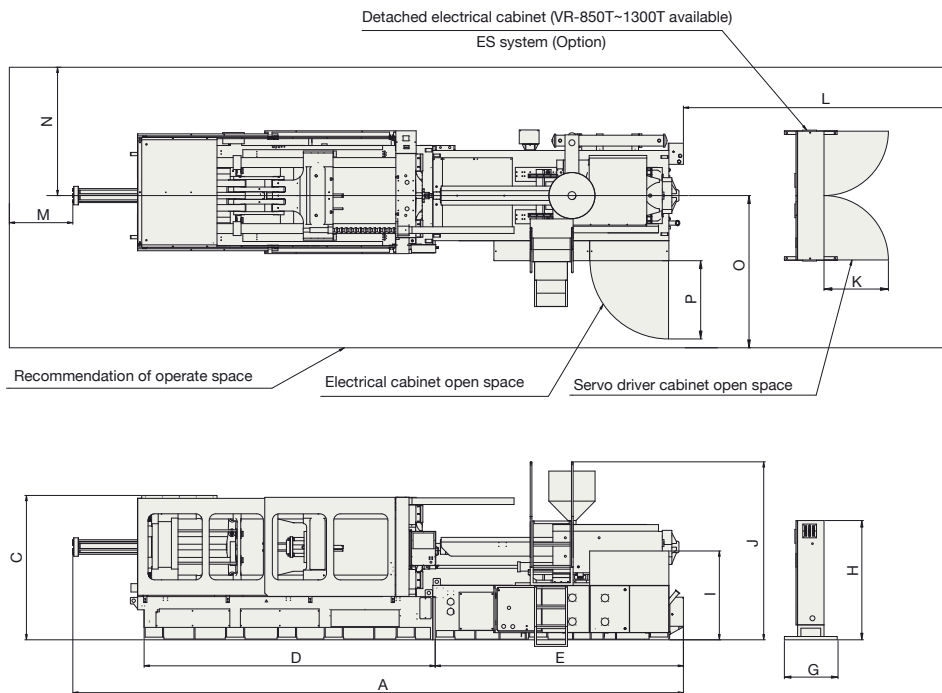

ITEM \ MODEL	Standard										ES (Option)				stairs (Option)	
	A	B	C	D	E	L	M	N	O	P	K	G	H	I	F	J
VR-350	7500	1950	2100	3840	3000	1000	1000	1975	2450	975	X	X	X	1450	700	2768
VR-450	8400	2050	2080	4445	3270	1000	1000	2025	2500	975	X	X	X	1450	700	2572
VR-550	9300	2150	2200	4580	3570	1000	1000	2075	2550	975	X	X	X	1450	700	2700
VR-700	9950	2950	2400	5255	4280	1000	1000	2475	2950	615	X	X	X	1450	700	2695
VR-850	10850	2500	2445	5320	4890	3600	1000	2250	2725	630	975	800	1800	X	700	2376
VR-1000	12595	2595	2568	6575	5456	3347	763	1860	2370	750	1202	820	1653	X	700	3042
VR-1300	13561	2856	2773	7035	5700	3131	522	2720	2300	750	1202	820	1653	X	700	3130



TAIWAN

<http://www.victortaichung.com>
E-mail: info@mail.or.com.tw

- Victor Taichung Machinery Works Co., Ltd.
No. 1, Jingke Central 2nd Rd.,
Nantun Dist., Taichung 40852,
TAIWAN, R.O.C.
TEL : 886-4-23592101
FAX : 886-4-23593389

FRANCE

- Victor France
TEL : 33-1-64772000
FAX : 33-1-64772063

GERMANY

- Victor GmbH
TEL : 49-2261-478434
FAX : 49-2261-478327

SOUTH AFRICA

- Victor Fortune (PTY) Ltd.
TEL : 27-11-3923800
FAX : 27-11-3923899

MALAYSIA

- Victor Machinery (M) SDN. BHD.
TEL : 60-3-56337180
FAX : 60-3-56337191

THAILAND

- Victor (Thailand) Co. Ltd.
TEL : 66-2-9263735
FAX : 66-2-9032373

INDONESIA

- PT. Victor Machinery Indonesia
TEL : 62-21-88958504
FAX : 62-21-88958513

USA

- Fortune International Inc.
TEL : 1-732-2140700
FAX : 1-732-2140701

CHINA

- Zhongtai Precision Machinery
(Guangzhou)
TEL : 86-20-82264885
FAX : 86-20-82264861